

# **Structured Packings** for Distillation, Absorption and Reactive Distillation

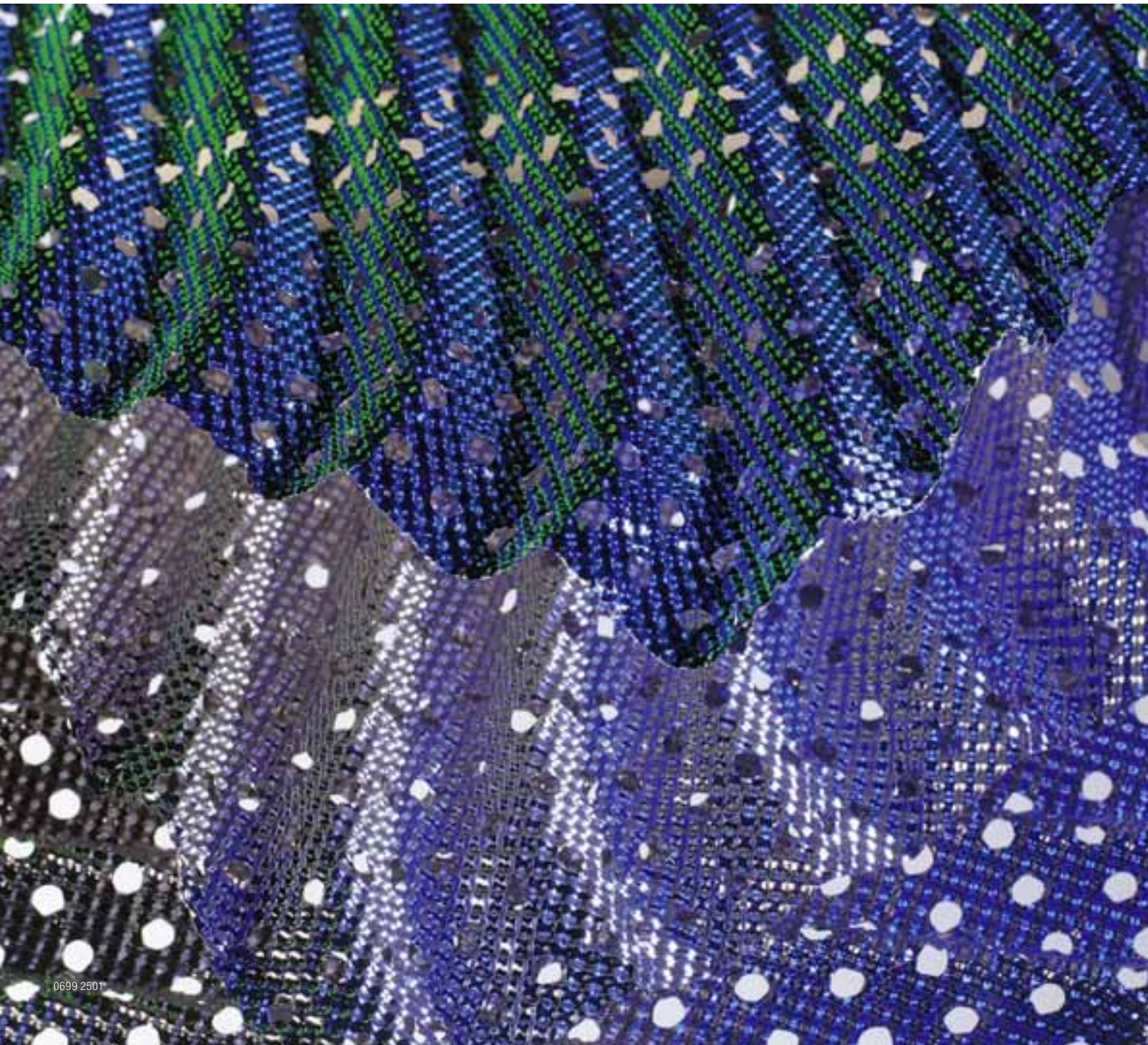

# Structured packings for separation and reactive distillation

This brochure was reviewed and supplemented in 2002/2003. It therefore provides a complete, up-to-date overview of packings available from Sulzer Chemtech.

Also included is a summary covering the essential column internals and our technical services.

For more detailed product information, we will gladly send you the following brochures/design tools:

## - Internals for Packed Columns

The brochure contains a comprehensive summary of the selection of internals supplied by Sulzer Chemtech, and a description of the most important features of the distributor technology.

## - Gas Processing

## - Chemical Processing Industry

## - Process Technology and Equipment for Oil Refineries and Crude Oil Production

Three brochures which illustrate the wide spectrum of application of structured packings.

## - Sulpak Design Program

A program that enables users to carry out hydraulic design of columns featuring every type of packing Sulzer Chemtech offers. The program is based on our experience with several thousand industrial columns and from experimental data measured in our own test column with a diameter of 1 m.

Considering the broad selection of products and widely proven application know-how, Sulzer Chemtech is in a position to offer the suitable solution even for the most difficult separation tasks.



## Contents

### Structured packings

• Overview	4-5
• Laboratory packings	6
• Mellapak®	7-9+14
• MellapakPlus®	10-11
• Gauze packings	12/13+15
• Mellacarbon®	16
• Mellagrid®	17
• Katapak®-SP	18

### Column design

• Engineering, Guarantee	25
• Formula notation	27

### Internals and erection

• Distributors	20
• Collectors	21
• Support grids	22
• Revamping	23

### Test facilities

• Distributor test facility	26
• Pilot plants	26

# Over 40 years of experience in mass transfer technology

Sulzer Chemtech has been active as equipment supplier to the chemical industry since the nineteen forties. In the early days the engineering design was completely dependent on the specification provided by customers. At the end of the fifties Sulzer was ready to offer its own solutions to specific chemical process engineering problems. These early activities laid the corner stone for sustained innovation by establishing an in-house development group and a well equipped pilot facility.

## Gauze packings

The invention of the gauze packings BX and CY in the early sixties resulted in a decisive breakthrough in distillation technology. The special advantages of these packings allowed difficult separation tasks to be accomplished for the very first time, and thermally sensitive substances to be separated by means of distillation.



## Mellapak

A further milestone was the development of the structured packings Mellapak in the seventies. Originally conceived to cover the moderate vacuum range up to atmospheric pressure, Mellapak opened up new and unforeseen perspectives in all areas of thermal mass transfer.

## Applications

The eighties were marked by the widening of the application range of Mellapak in the petrochemical, oil and gas industries as well as in exhaust air cleaning and in the stripping of volatile constituents from wastewater. Typical examples are vacuum towers in refineries and high-pressure absorption columns

for natural gas drying. In comparison to conventional technology, Mellapak offers substantial benefits in many process applications. During the past 40 years, thousands of columns, originally equipped with trays or random packings, have been revamped with Mellapak in order to improve yield or purity or to increase



capacity. Due to extensive test data gathered in our process engineering laboratory as well as experience gained in numerous industrial applications, the majority of solutions can be offered together with a guarantee for product purity and capacity.

## Column Internals

With the concept of advanced internals, Sulzer Chemtech has defined the standard for gas and liquid distribution in packed columns. Distributors are available for a wide range of applications and operating conditions.

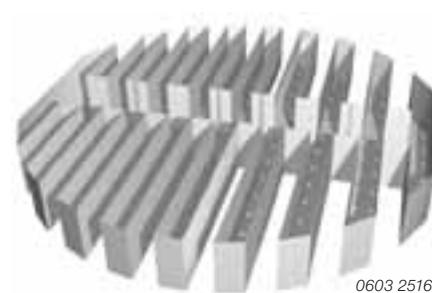

## MellapakPlus

- MellapakPlus represents the novel, high capacity structured packing (typically 25 to 30 % more capacity compared with conventional structured packing)
- MellapakPlus offers significantly lower pressure drop
- MellapakPlus offers a wide range of technical and commercial advantages
- MellapakPlus can be used from low vacuum up to high pressure applications
- Everything one already knows about Mellapak remains valid for MellapakPlus

# Structured packings from Sulzer Chemtech

	Type of packing	Material
	Mellapak 64.X/64.Y Mellapak125.X/125.Y Mellapak170.X/170.Y Mellapak 2 X/2 Y Mellapak 250.X/250.Y Mellapak 350.Y  Mellapak 500.X/500.Y Mellapak 750.Y Further types on request	Stainless steels Carbon steel Hastelloy, monel, aluminum, copper-bronze, brass, titanium, nickel Other materials available on request
	MellapakPlus 202.Y MellapakPlus 252.Y MellapakPlus 352.Y MellapakPlus 452.Y MellapakPlus 752.Y Further types on request	Stainless steels Carbon steel Hastelloy, monel, aluminum, copper-bronze, brass, titanium, nickel, Other materials available on request
	Mellapak 125.X/Y Mellapak 250.X/Y from plastics	PP, PVC-C, PVDF, Teflon® PFA
	Mellagrid 40.Y Mellagrid 64.X Mellagrid 64.Y Mellagrid 90.X	Stainless steels Carbon steel Other materials available on request
	BX gauze packing BXPlus gauze packing CY gauze packing	Stainless steels Copper-bronze, monel, hastelloy, nickel, titanium Other materials available on request
	BX gauze packing from plastics	Gauze - made of polypropylene/ polyacrylonitrile mixture (PP/PAN)
	Mellacarbon 125.Y Mellacarbon 250.Y Mellacarbon 350.Y Mellacarbon 500.Y	Carbon (CFC)
	DX laboratory packing EX laboratory packing DXM, DYM laboratory packing made from sheet metal	CrNiMo steel Alloy C22 Carbon (CFC)
	Katapak-SP 11 Katapak-SP 12 Katapak-SP 13	Stainless steels Other steels available on request

Applications	Diameter and operation range	Characteristics
Basic chemicals and petrochemicals, ethylbenzene/styrene, fatty acids, tall oil, cyclohexanone/-ol, caprolactam, refinery operations, absorption/desorption columns, natural gas drying	From 80 mm up to 17 m (depending on type) Vacuum to high pressure Liquid load 0.2 to more than 200 m <sup>3</sup> /m <sup>2</sup> h	Universal packing type, suitable for a wide range of applications Low to very high liquid loads
Basic chemicals and petrochemicals, ethylbenzene/styrene, fatty acids, tall oil, cyclohexanone/-ol, caprolactam, refinery operations, absorption/desorption columns, natural gas drying	From 80 mm up to 12 m (depending on type) Vacuum to high pressure Liquid load 0.2 to more than 200 m <sup>3</sup> /m <sup>2</sup> h	Universal packing type Boosts useful capacity
Absorption/desorption columns	From 200 mm up to 15 m (depending on type) Vacuum to high pressure Temperature: PP max. 110 °C, PVDF max. 150° C	Resistant to many chemicals Small pressure drop Separation efficiency similar to Mellapak made from metal
Refineries and petrochemical industry Crude oil distillation Quench columns	Minimum diameter 900 mm Vacuum to high pressure	Robust construction Smooth surface No blockage, not sensitive to fouling Excellent flow stabiliser Efficient de-entrainment device
Fine chemicals Isomers Fragrances Flavours	From 40 mm up to 6 m (depending on type) Pressure 1 mbar to atmospheric pressure, optimum: 1-100 mbar	High separation efficiency, even at small liquid loads Low pressure drop Small hold-up BXPlus: Same efficiency as BX, lower pressure drop
Low liquid loads with aqueous solutions	From 100 mm up to 4 m (depending on material) Pressure 1 mbar to moderate pressure Temperature max. 80 °C	Self-wetting, even with aqueous solutions Large number of transfer units per meter, even with small liquid loads Low pressure drop
Hydrofluoric acid, carboxylic acid, caustic solutions	From 30 mm Vacuum to moderate pressure Temperatures up to more than 400 °C	High separation performance Best chemical resistance and thermal stability Low pressure drop
Laboratory and pilot columns	DX, DXM, DYM 30-125 mm, EX 20-85 mm Vacuum to atmospheric pressure	Smallest hydraulic diameter EX, DX: Very high number of theoretical stages per meter, low pressure drop DXM, DYM: Constant HETP over the whole F factor range
Acetates, methyl acetate hydrolysis, fatty acid esters Acetals MTBE, ETBE, TAME	From 50 mm Vacuum to moderate pressure	Packing for reactive distillation and trickle-bed reactors High separation efficiency and high reaction capacity Modular concept

# Laboratory packing

Highest number of theoretical stages per unit height



0691 2532-2

Standard structured packings are hardly suitable for use in laboratory columns of less than 50 mm diameter. Sulzer laboratory packings are especially designed for this purpose.

### Preferred applications:

- Laboratory columns from 20 to 80 mm
- Vacuum from 1 mbar
- Where a high number of theoretical stages is required (DX, EX)
- Distillation of components prone to decomposition
- Preliminary assessment of a separation task
- Deriving of reliable scale-up rules

### Special features:

Small pressure drop

Type EX:

- Highest possible number of theoretical stages, even with very low liquid loadings
- Same pressure drop per theoretical stage as Sulzer BX packing
- Small hold-up
- Capacity nearly double that of wire mesh rings (3 x 3 mm)

Type DX:

This packing has a coarser structure and hence a lower number of theoretical stages. Suitable for laboratory columns where a modest number of theoretical stages is required, together with low pressure drop and high capacity.

Type DXM/DYM:

These packing types, made of sheet metal, have a lower number of theoretical stages compared to DX. HETP or NTSM remain constant over a wide range of F factors and liquid loads. This makes scale-up significantly easier.

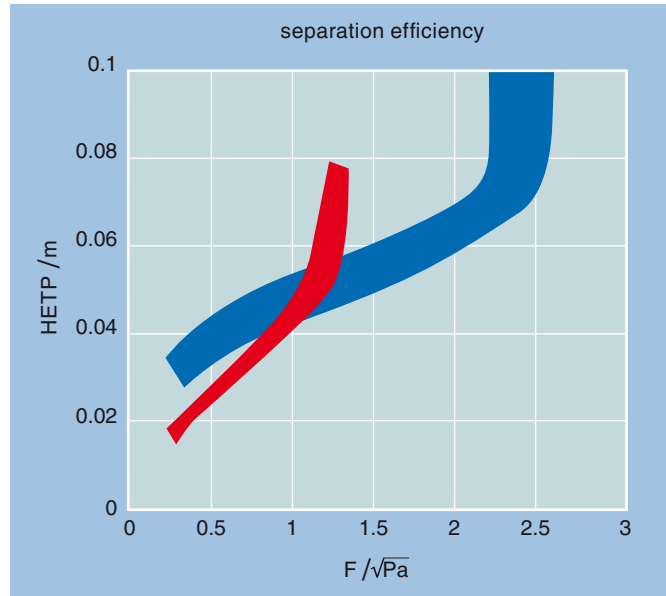

EX

DX

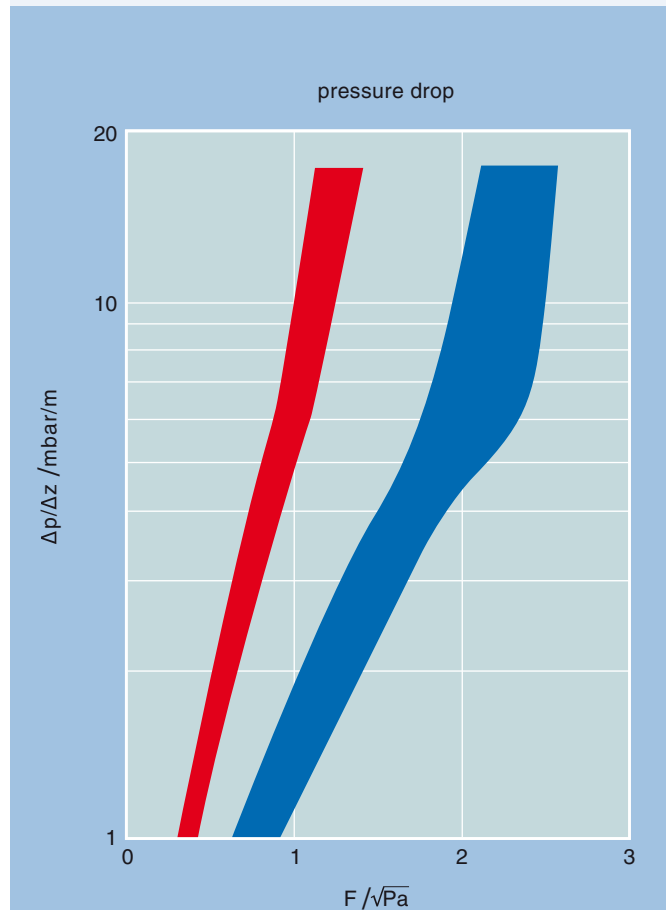

### Laboratory packings

Head pressure = 50 mbar

# Mellapak 250.Y/X

## A highly versatile packing type



0602 2510

Mellapak is the most widely used structured packing worldwide. It has proven excellent performance in columns with diameters up to 15 m. It is supplied in sheet metal thicknesses from 0.1 mm up.

### Special features

- Pressure drop per theoretical stage 0.3-1.0 mbar
- Pressure drop at 70-80% flooding about 2 mbar/m
- Minimum liquid load approx.  $0.2 \text{ m}^3/\text{m}^2\text{h}$
- Maximum liquid load up to more than  $200 \text{ m}^3/\text{m}^2\text{h}$  (typically in desorption columns)

### Preferred applications

- Vacuum to moderate pressure
- High pressure in selected applications
- Increasing capacity of existing tray and packed columns

### Typical applications

- Chemical industry: Ethylbenzene/styrene, tall oil, cyclohexanone/-ol, air separation
- Petrochemical industry: Quench columns,  $\text{C}_3$ - and  $\text{C}_4$ - splitters, xylene splitters
- Refineries: Vacuum and atmospheric columns
- Absorption: Natural gas drying,  $\text{CO}_2$ - and  $\text{H}_2\text{S}$ -absorbers and strippers, ethyleneoxide absorbers and strippers, acrylonitrile absorbers

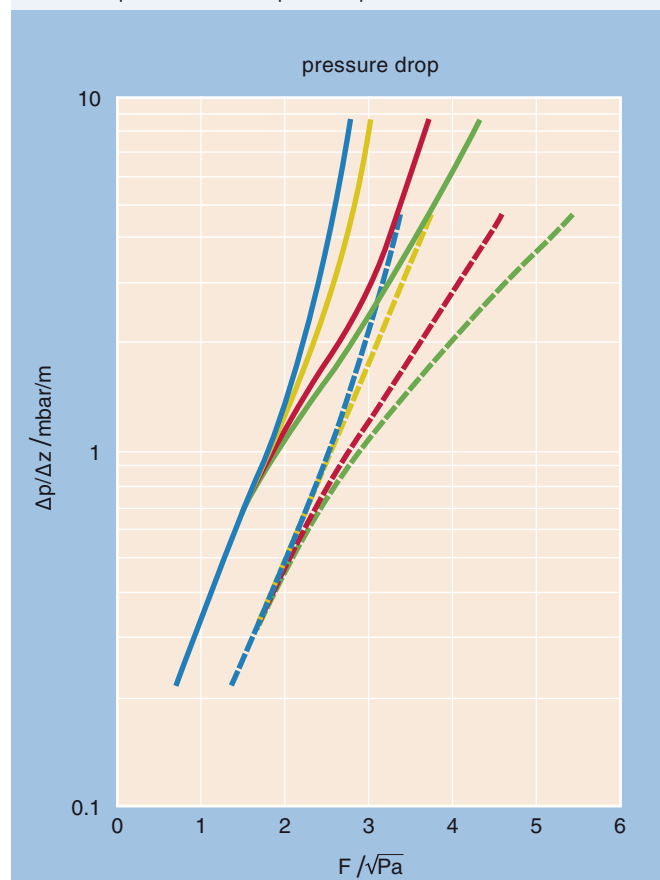
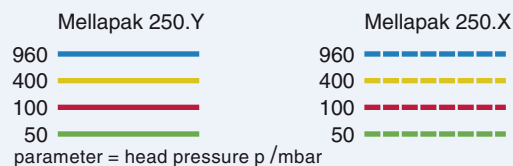
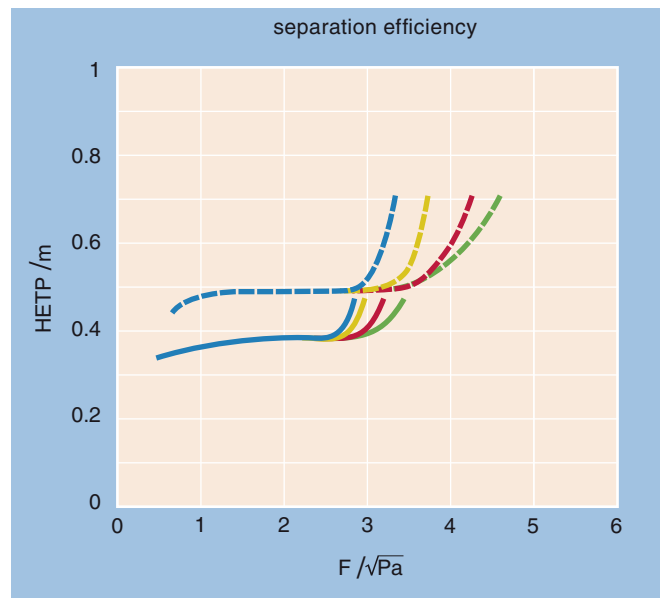

**Mellapak 250.Y**  
**Mellapak 250.X**

# Mellapak

A solution available for any application

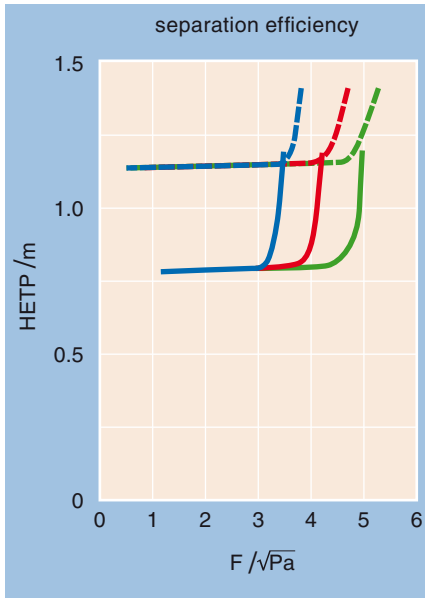

Mellapak 125.Y Mellapak 125.X  
 960 — 960 - - -  
 100 — 100 - - -  
 50 — 50 - . .  
 parameter = head pressure  $p$  / mbar

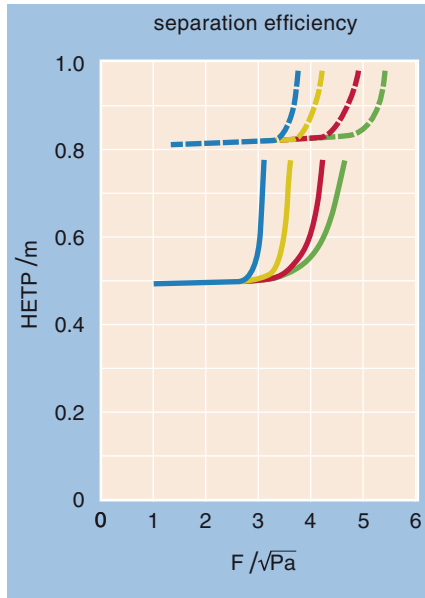

Mellapak 170.Y Mellapak 170.X  
 960 — 960 - - -  
 400 — 400 - - -  
 100 — 100 - . .  
 50 — 50 - . .  
 parameter = head pressure  $p$  / mbar

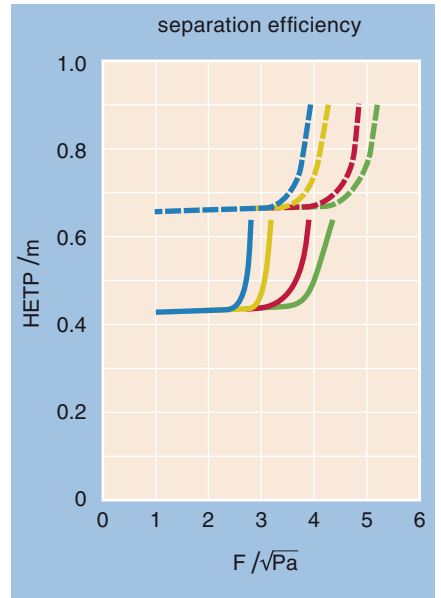

Mellapak 2Y Mellapak 2X  
 960 — 960 - - -  
 400 — 400 - - -  
 100 — 100 - . .  
 50 — 50 - . .  
 parameter = head pressure  $p$  / mbar

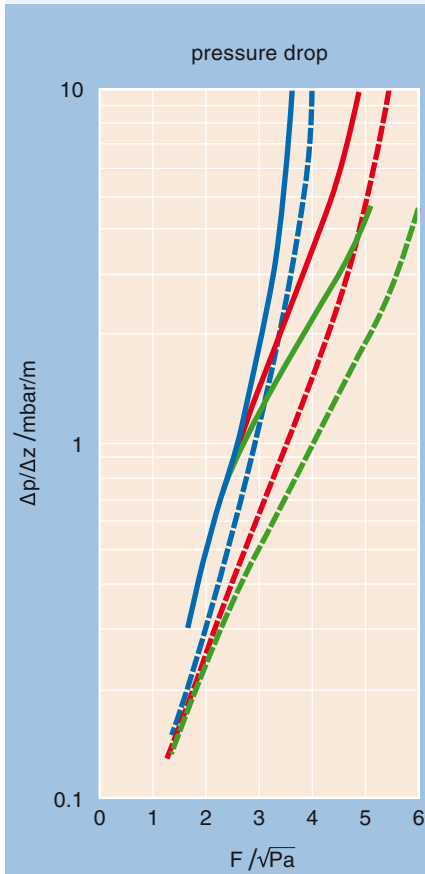

**Mellapak 125.Y**  
**Mellapak 125.X**

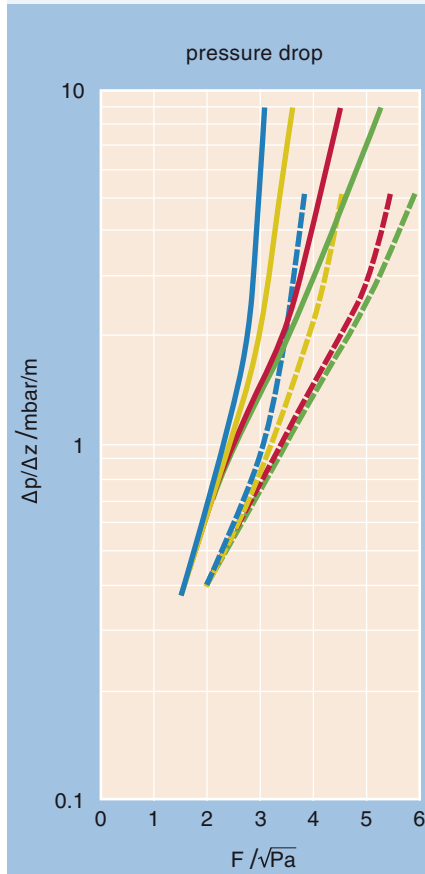

**Mellapak 170.Y**  
**Mellapak 170.X**

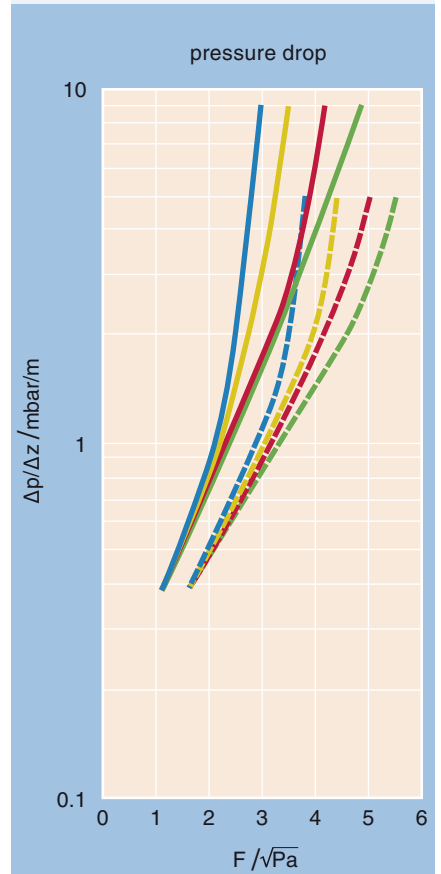

**Mellapak 2Y**  
**Mellapak 2X**



# Mellapak

A solution available for any application

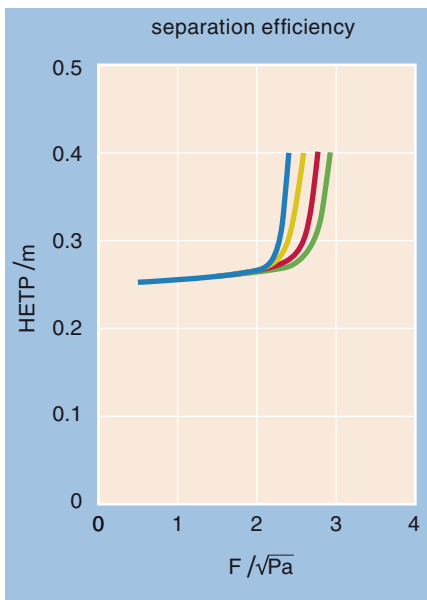

Mellapak 350.Y  
 960 ———  
 400 ———  
 100 ———  
 50 ———  
 parameter = head pressure p /mbar

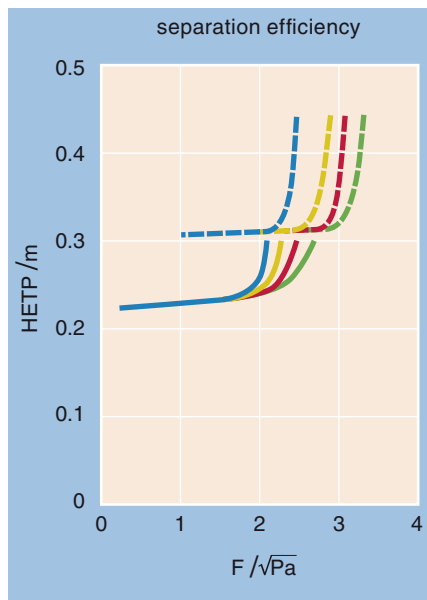

Mellapak 500.Y Mellapak 500.X  
 960 ——— 960 - - -  
 400 ——— 400 - - -  
 100 ——— 100 - - -  
 50 ——— 50 - - -  
 parameter = head pressure p /mbar

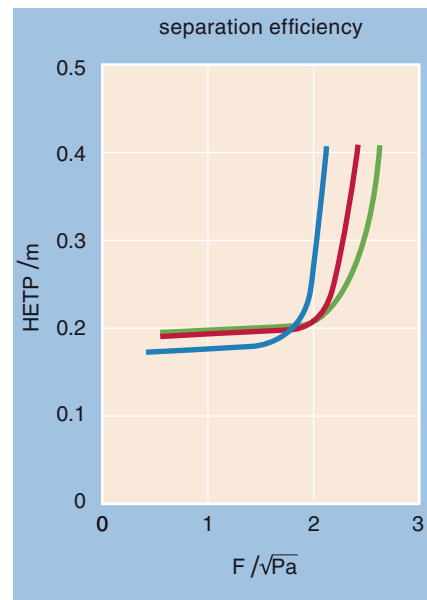

Mellapak 750.Y  
 960 ———  
 100 ———  
 50 ———  
 parameter = head pressure p /mbar

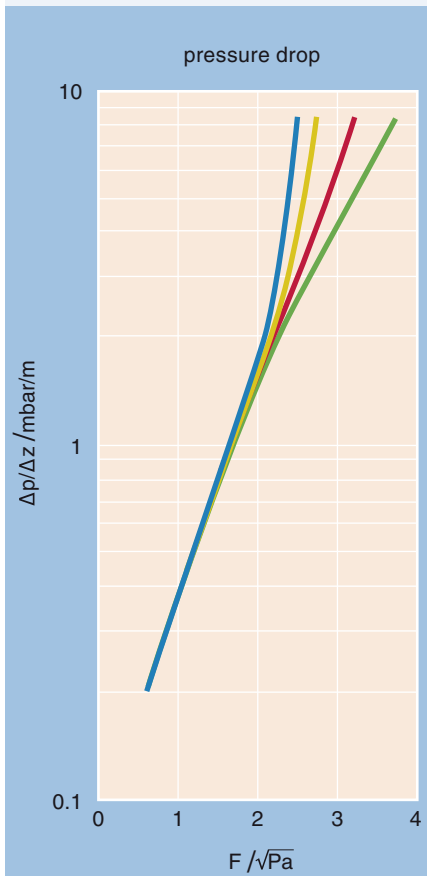

**Mellapak 350.Y**

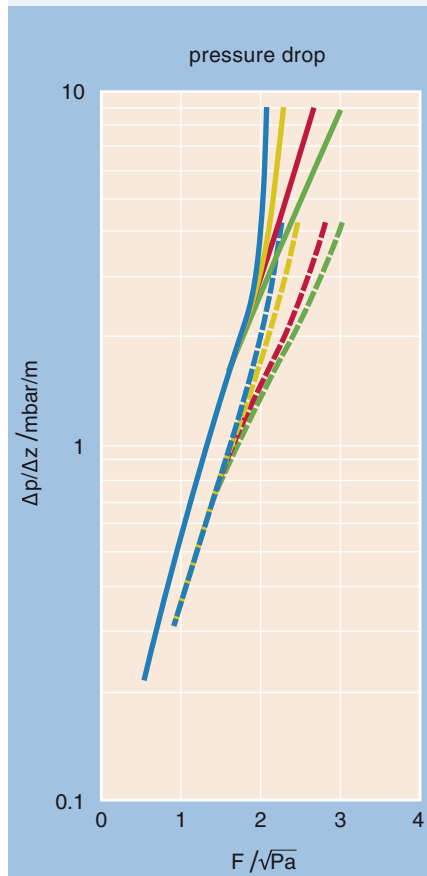

**Mellapak 500.Y**  
**Mellapak 500.X**

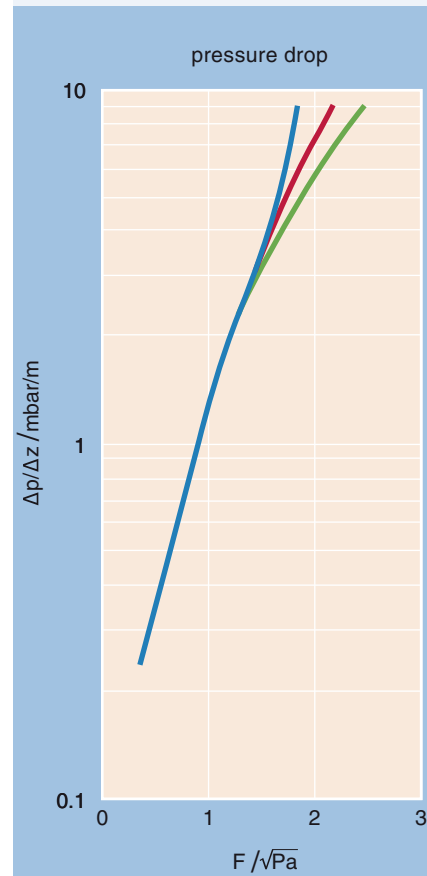

**Mellapak 750.Y**

# MellapakPlus

## A new generation of structured packings

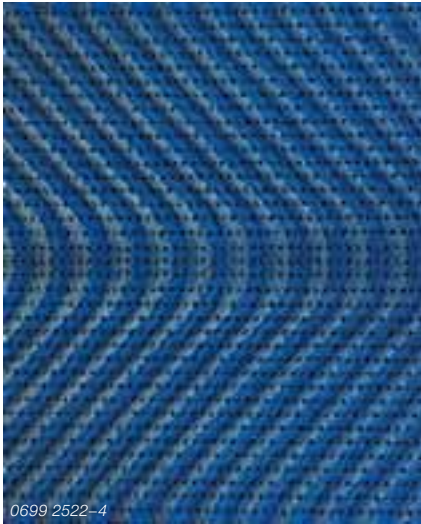

MellapakPlus is a capacity enhanced structured packing. It combines all advantages of the metal sheet packing Mellapak with new geometrical features.

### Features of MellapakPlus

At the lower and upper end of each packing element, the orientation of the corrugation gradually approaches the vertical axis. Advantages of this geometrical modification:

- The vapor flow smoothly changes direction at the interface between two packing elements
- At the interface vapor flow is nearly parallel to the vertical axis of the column. The gas velocity is therefore reduced by about 25% compared to the velocity inside the packing element

Both factors reduce the pressure drop and the shear forces, which are especially critical at the interface due to the presence of thicker and less stable liquid films. As a result, premature flooding at the interface is no longer of concern.

In the interior part of the packing element the geometrical features of MellapakPlus and Mellapak are identical. Hence, separation efficiency is similar – but with a significant increase in capacity and a reduction in pressure drop. All other MellapakPlus properties – including installation procedure, mechanical strength and corrosion resistance – are identical to Mellapak.

MellapakPlus performance has been confirmed in category 1 tests at F.R.I.

### Internals

The close resemblance between MellapakPlus and Mellapak guarantees continued use of the whole range of well known and reliable internals. Internals are now able to handle the increased gas load typical for the high capacity of MellapakPlus. Sulzer Chemtech is committed to the on-going, focused development of novel designs.

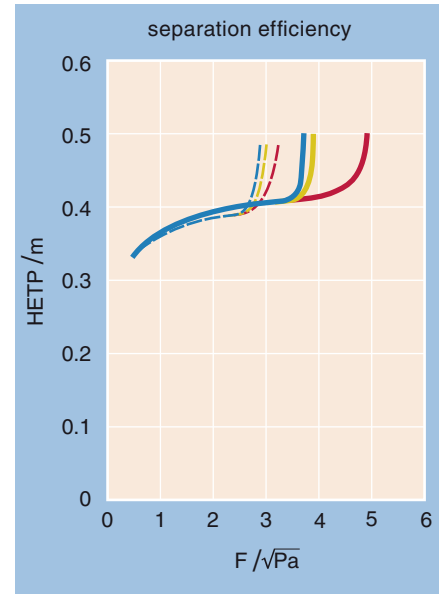

MellapakPlus 252.Y	Mellapak 250.Y
960 ———	960 - - - -
400 ———	400 - - - -
100 ———	100 - - - -

parameter = head pressure p / mbar

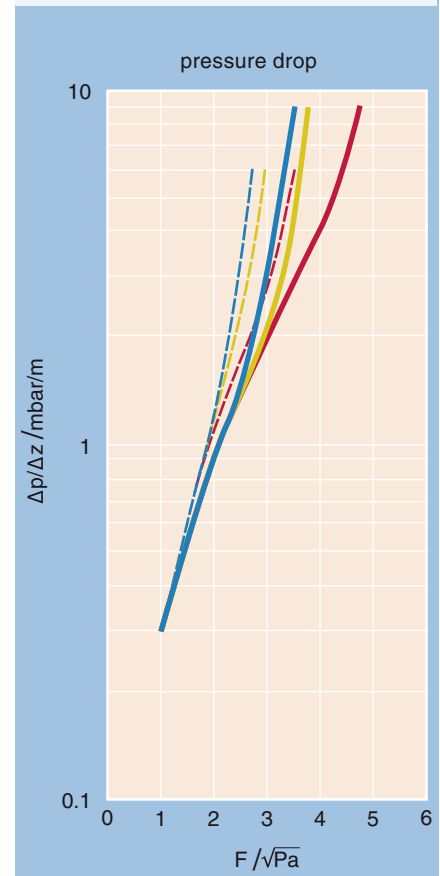

**MellapakPlus 252.Y vs.  
Mellapak 250.Y**

# MellapakPlus

## A new generation of structured packings

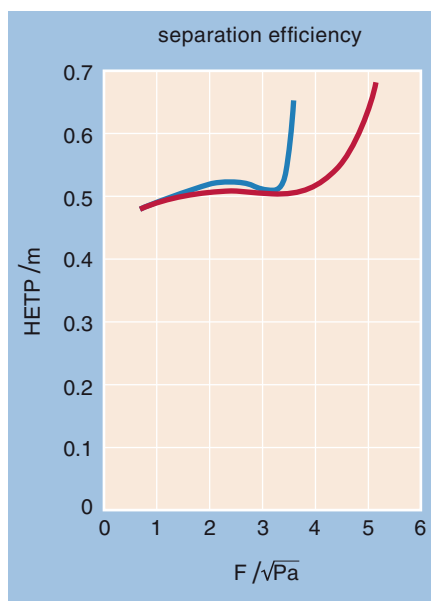

MellapakPlus 202.Y

960 ———

100 ———

parameter = head pressure p /mbar

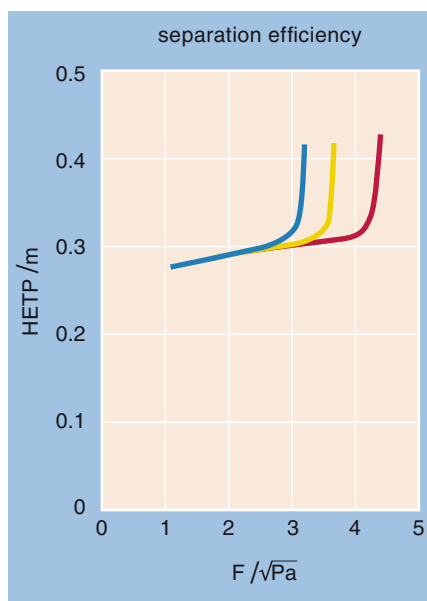

MellapakPlus 352.Y

960 ———

400 ———

100 ———

parameter = head pressure p /mbar

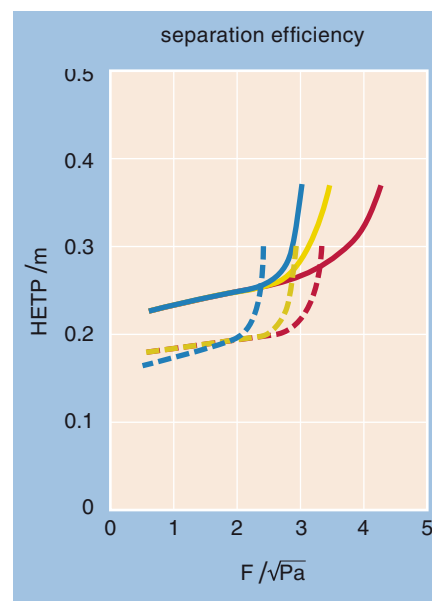

MellapakPlus 452.Y MellapakPlus 752.Y

960 ——— 960 - - - -

400 ——— 400 - - - -

100 ——— 100 - - - -

parameter = head pressure p /mbar

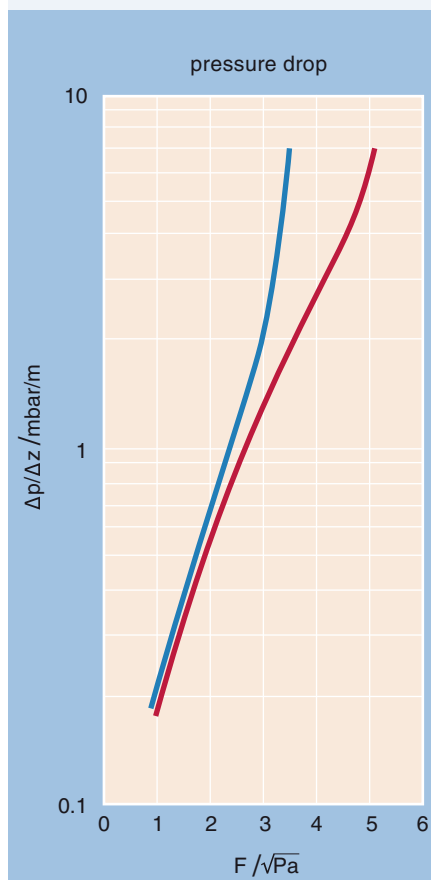

MellapakPlus 202.Y

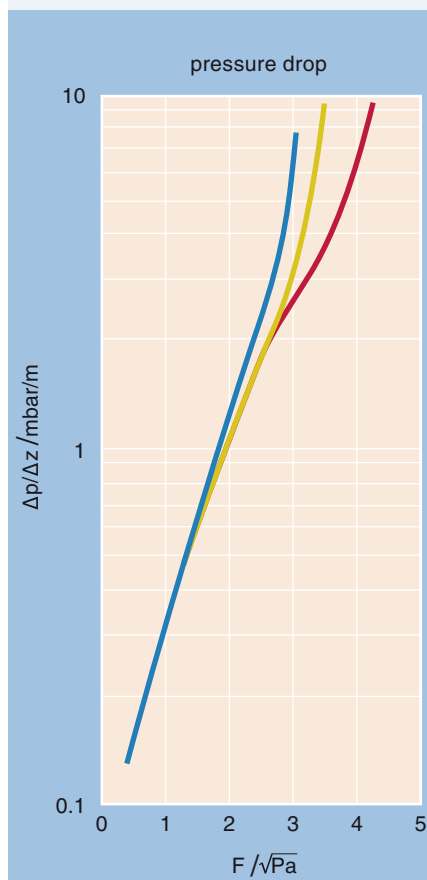

MellapakPlus 352.Y

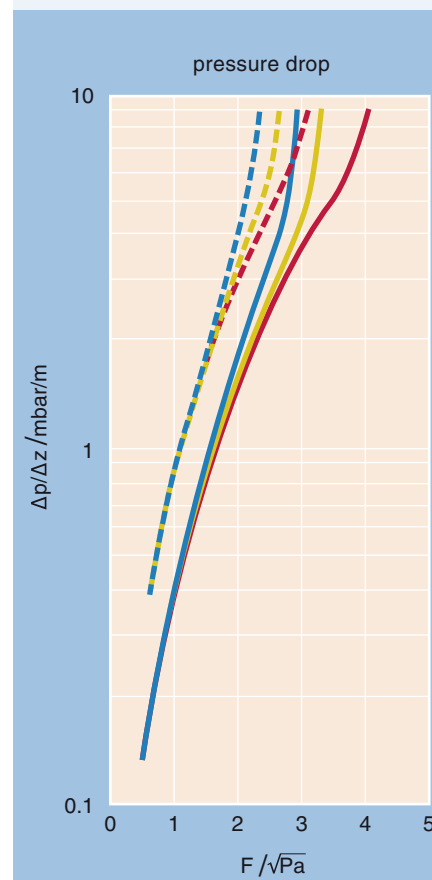

MellapakPlus 452.Y  
MellapakPlus 752.Y

# Gauze packings

## Sulzer metal gauze packing, type BX and BXPlus



0682 2017

This packing has been successfully employed in the industry for over 40 years. Largest diameter supplied to date: 6 m.

### Special features

- High number of theoretical stages per unit height
- Pressure drop per theoretical stage 0.1–0.5 mbar
- Most economical load range:  
F factor 1-2.5  $\sqrt{Pa}$
- Minimum liquid load approx. 0.05 m<sup>3</sup>/m<sup>2</sup>h
- Small hold-up

### Preferred applications

- Large number of theoretical stages
- Vacuum from 1 mbar to atmospheric pressure
- Where minimum pressure drop per theoretical stage is important
- Small overall height
- Batch and continuous columns
- Pilot columns (reliable scale-up)

Limited suitability for

- Fouling substances
- Non-wetting liquids

### Product applications

- Monomers from plastics (MDI, DMT, etc.)
- Fatty acids, fatty alcohols, fatty acid esters
- Mono-, di-, tri-, and tetraethylene glycols
- Fine chemicals

### BXPlus

BXPlus is a further development of the well proven gauze packing BX. Its geometry is similar to MellapakPlus. BXPlus offers the same efficiency as BX with a 20% lower pressure drop. It is recommended for gentle distillation at higher capacity.

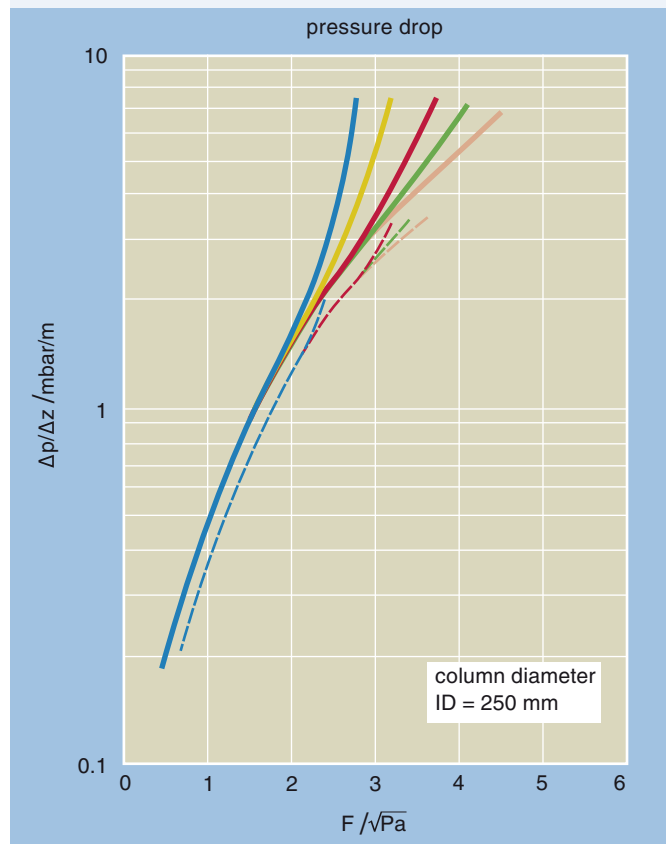
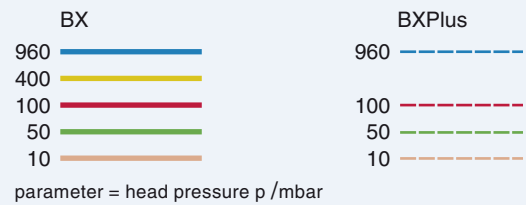
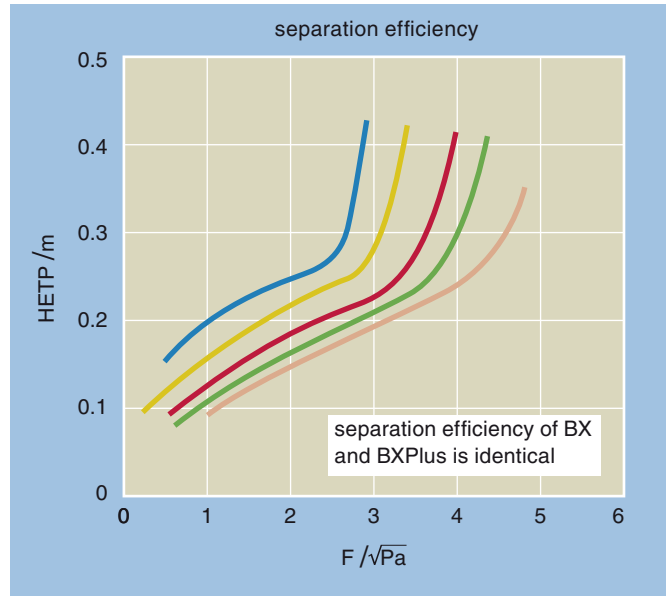

Gauze packing BX  
Gauze packing BXPlus

# Gauze packings

## Sulzer metal gauze packing, type CY



4588 3043

This packing was developed for separations that require a large number of theoretical stages. Largest diameter supplied to date: 1.8 m.

### Special features

- Maximum number of theoretical stages per meter
- Most economical load range:  
F factor  $1.5-2 \sqrt{\text{Pa}}$
- Minimum liquid load approx.  $0.05 \text{ m}^3/\text{m}^2\text{h}$
- Small hold-up

### Preferred applications

- For a very large number of theoretical stages
- Vacuum from 1 mbar to atmospheric pressure
- Small overall height
- Batch and continuous columns
- Pilot and laboratory columns (reliable scale up)

Limited suitability for

- Fouling substances
- Non-wetting liquids

### Product applications

- Pharmaceutical products (vitamins, etc.)
- Fragrances (menthol, geraniol, etc.)
- Separation of isomers

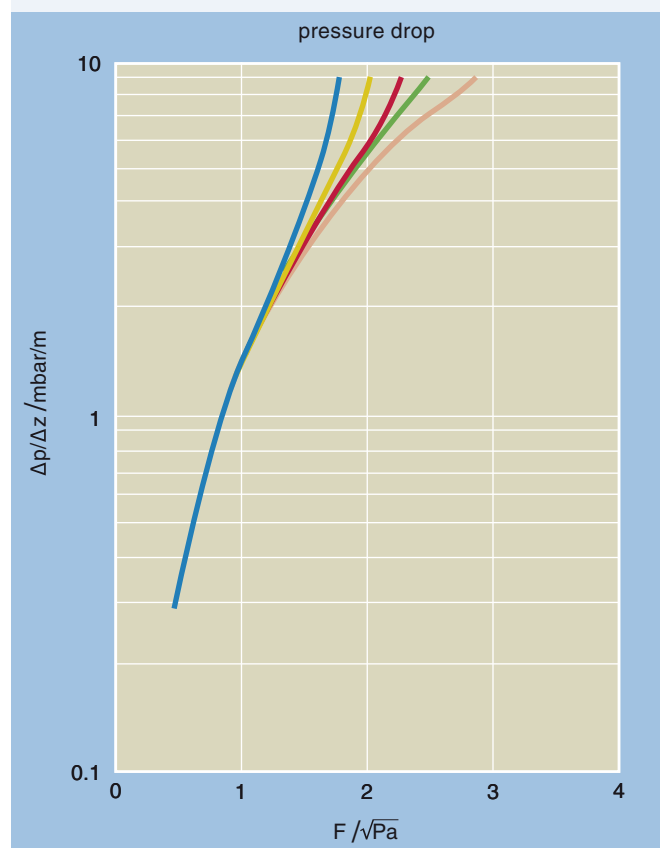
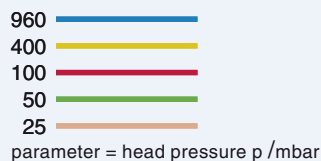
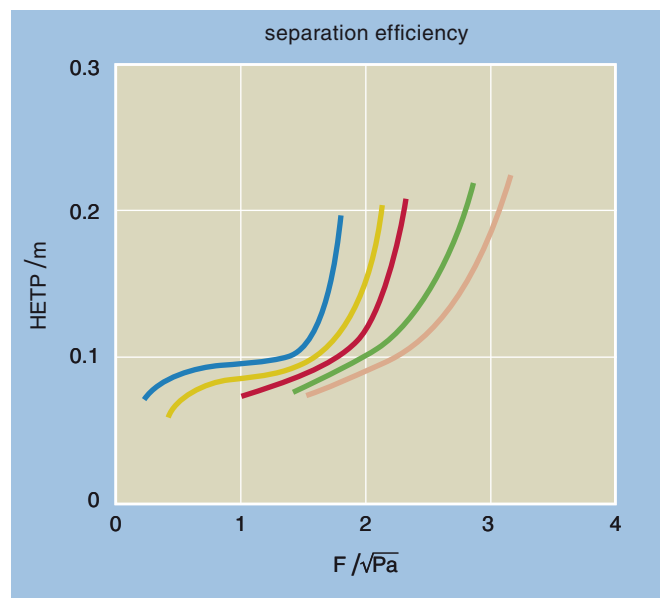

Gauze packing CY

# Mellapak in plastics



0682 2021

The MELLAPAK 125.X, 125.Y, 250.X and 250.Y (further types on request) are also available in different kinds of thermoplastics. Packings made of polypropylene (PP), postchlorated polyvinylchloride (PVC-C), polyvinylidenedifluoride (PVDF) and Teflon® PFA can be supplied.

The plastic versions of MELLAPAK have proven operational record in various types of absorption and desorption columns.

## Special features

- Large number of transfer units per meter, low HTU, depending on the system
- Small pressure drop per meter packed height
- Most economical load range up to F factor  $3 \sqrt{\text{Pa}}$
- Maximum operating temperatures:  
About 110 °C for polypropylene  
About 150 °C for PVDF packing

## Product applications

- HCl absorbers
- SO<sub>2</sub> absorbers
- Flue gas cleaning columns
- Sea water deaerators

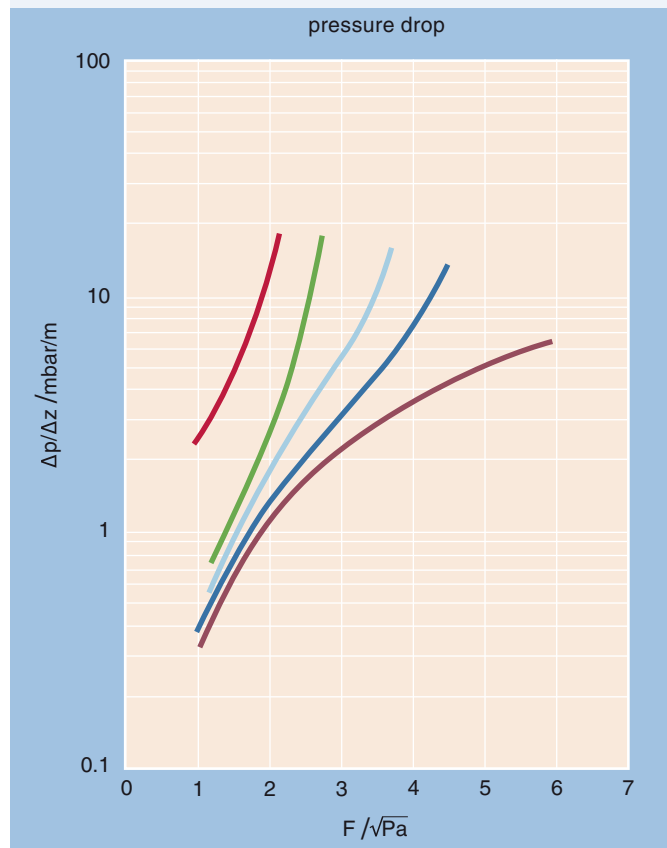
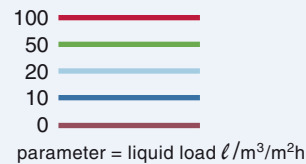
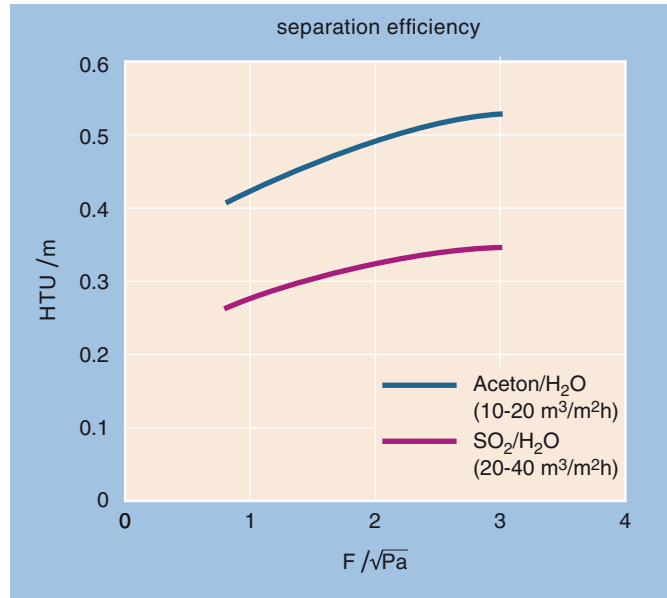

**Mellapak 250.Y PP**  
atmospheric pressure

# Gauze packings

## Sulzer plastic gauze packing, type BX



0682 2020

The plastic gauze packing has been used industrially with great success for many years. The special gauze structure provides a very good wettability, even in aqueous systems. This packing is used primarily for columns with low liquid loads.

### Special features

- Large number of transfer units per meter, low HTU, depending on the system
- Minimum pressure drop, typically 2–4 mbar/m
- Minimum liquid load approx.  $0.05 \text{ m}^3/\text{m}^2 \text{ h}$
- Self-wetting packing surface, even for aqueous solutions
- Operating temperatures up to  $80 \text{ }^\circ\text{C}$ , depending on the chemical components

### Preferred applications

- Small liquid loads
- Increasing performance of existing columns
- Columns with small overall height

### Product applications

- Methanol absorbers
- Isopropanol absorbers
- Dimethylformamide absorbers
- Formaldehyde absorbers

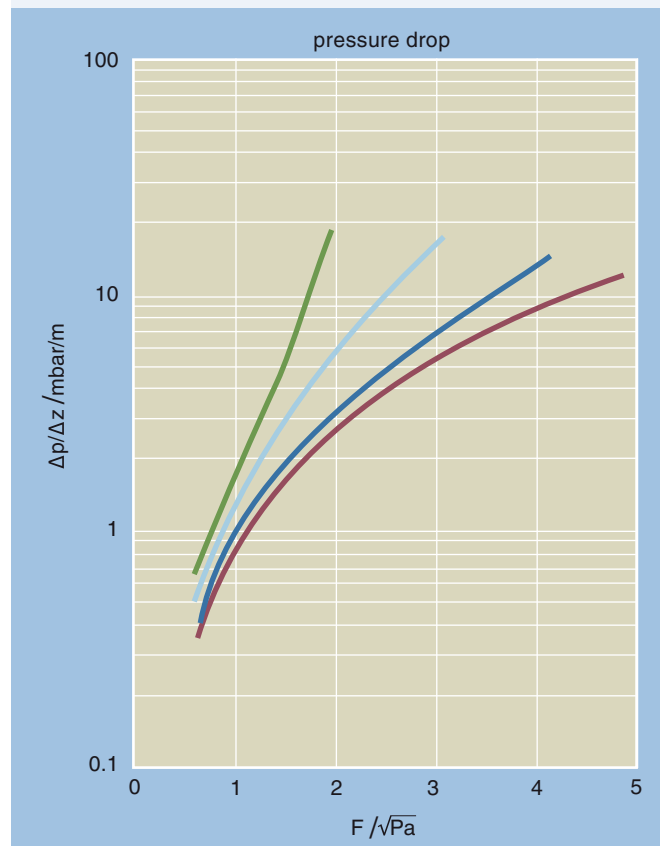
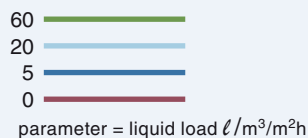
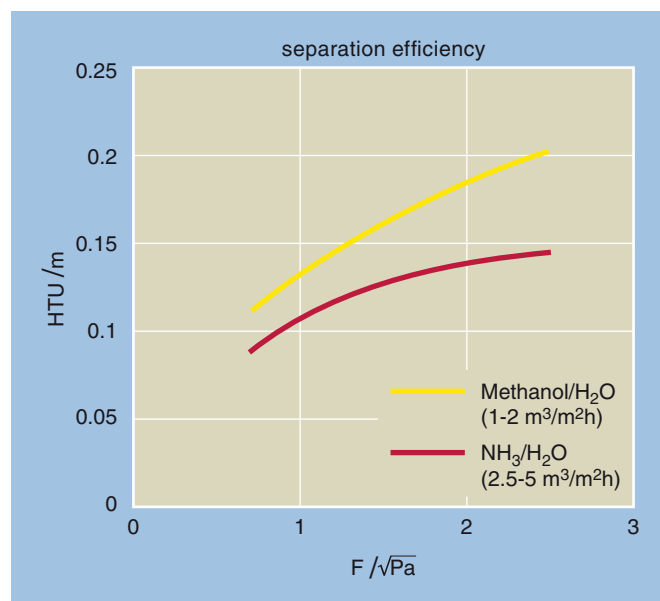

### Plastic gauze packing BX

atmospheric pressure, ID = 300 mm

# Mellacarbon – pure carbon



0697 2522

Carbon does not react with most solvents, acids or lyes. Sulzer Chemtech offers various Mellacarbon types.

- Corrosion-proof against caustic solutions, non-oxidizing inorganic acids including hydrofluoric acid and carboxylic acids
- Excellent wettability, also in aqueous systems
- Specific surface area of 125–1700 m<sup>2</sup>/m<sup>3</sup>
- High thermal stability (> 400 °C)

## Product applications

- HCl separation for production and for HCl recovery (typically in the production of polycarbonate)
- MCA / DCA distillation
- Production of phosphoric acid
- Concentration of hydrofluoric acid
- Separation of chlorophenols

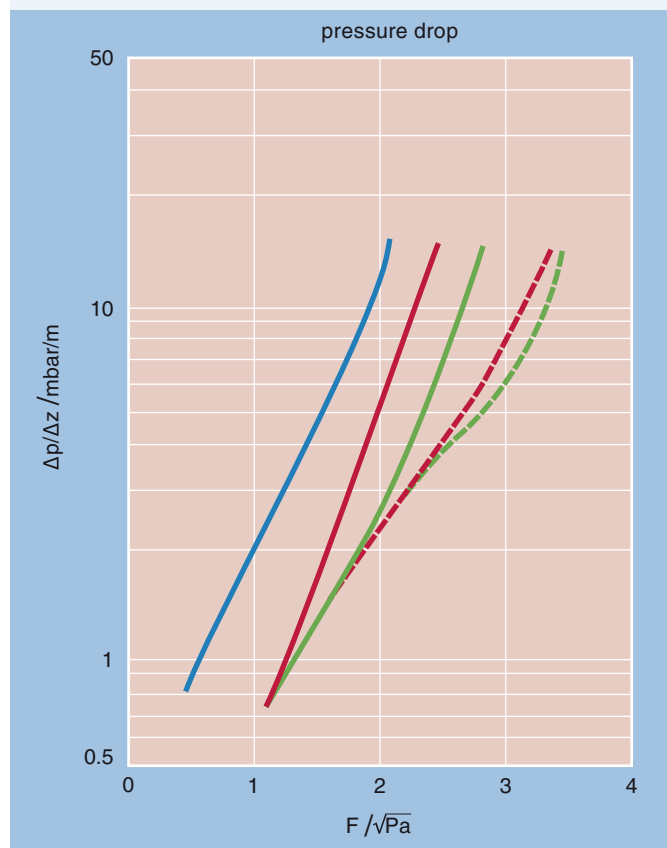
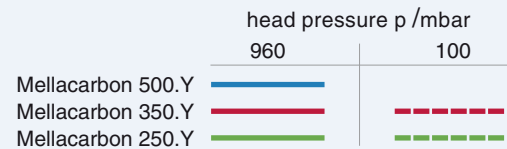
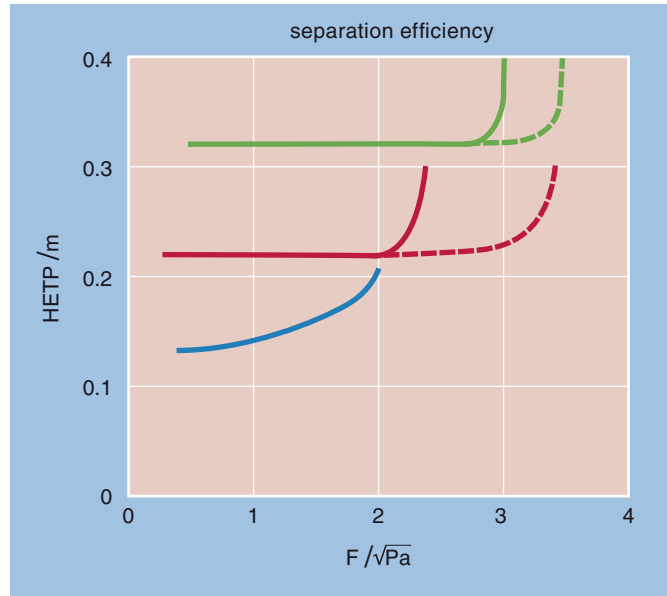

Mellacarbon



# Mellagrid

## Sulzer structured grid packings



With Mellagrid, Sulzer Chemtech combines the efficiency of structured packings with the mechanical resistance of a grid. Mellagrid is used wherever the mechanical strength of structured packings is a concern or where coking is likely to occur.

### Technical Data

Mellagrid	90.X	64.X	64.Y	40.Y
Specific surface area	90 m <sup>2</sup> /m <sup>3</sup>	64 m <sup>2</sup> /m <sup>3</sup>	64 m <sup>2</sup> /m <sup>3</sup>	40 m <sup>2</sup> /m <sup>3</sup>
Element height (approx.)	140 mm	220 mm	130 mm	200 mm
Surface structure	smooth			
Material thickness	0.5 to 2 mm			
Material	AISI 410S or 316L, other materials upon request			

### Special features

- Not sensitive to coking and fouling due to its smooth surface and geometrical structure
- Efficient dissipation of temperature
- Better de-entrainment and separation efficiency than a traditional grid
- The low element height and its structure allow for easy cleaning. It can be removed, unscrewed and cleaned with a water jet
- Mechanically robust structure

### Applications

- Atmospheric or vacuum tower: Wash section
- FCC Main Fractionator: Slurry pumparound section
- Coker or Visbreaker Fractionator: Wash section

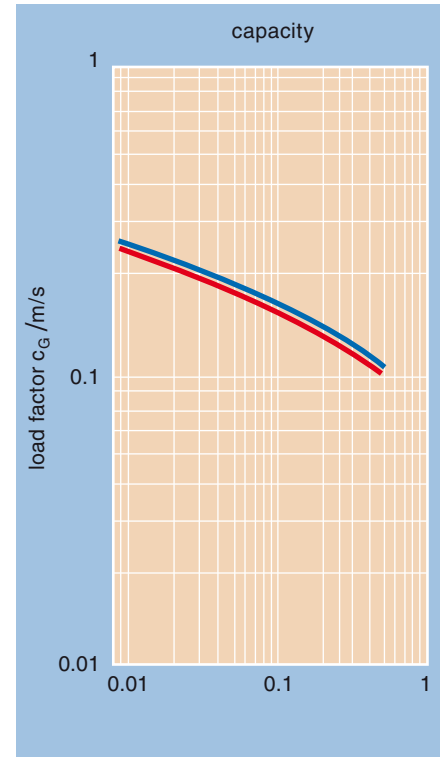

40.Y 64.Y 64.X 90.X

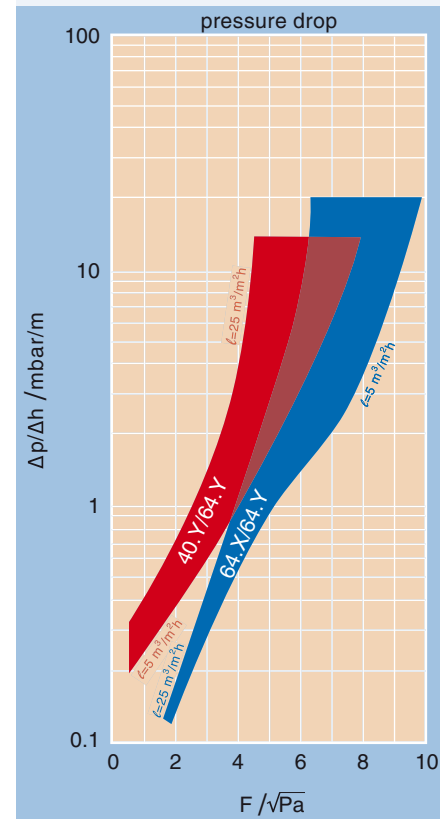

### Mellagrid

various liquid loads, air/water,  
T=30 °C, atmospheric pressure

# Katapak-SP

## Sulzer reactive distillation packing

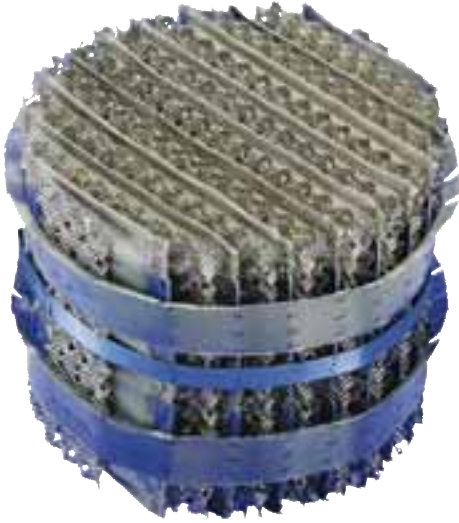

0600 2701-6

This packing was developed to be applied in reactive distillation processes. With the modular concept separation efficiency and catalyst volume fraction can be varied to perfectly fit the requirements of each specific process. Other types are available on request. Largest diameter supplied to date: 2 m.

### Special features:

- Flexible design combining catalyst elements and MellapakPlus layers
- High separation efficiency
- High reaction capacity

### Product applications:

- Synthesis of acetates (e.g. butyl acetate)
- Hydrolysis of methyl acetate
- Synthesis of fatty acid esters
- Synthesis of acetals
- MTBE, ETBE, TAME

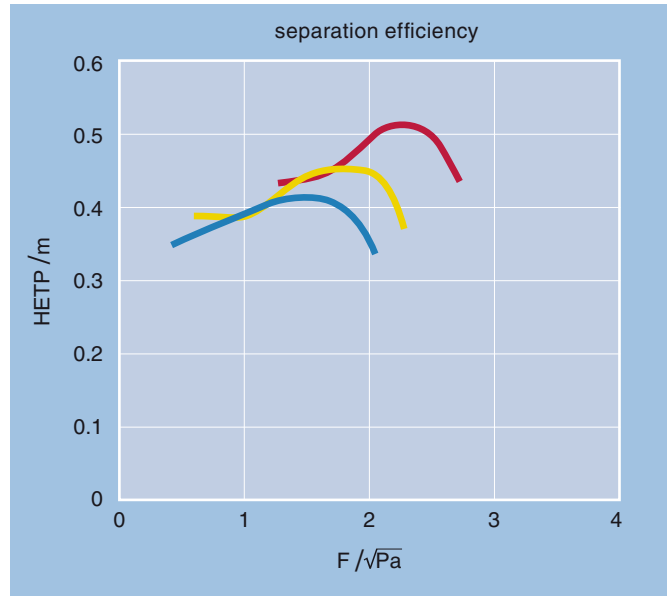

Katapak-SP 12

960

400

100

parameter = head pressure  $p$  /mbar

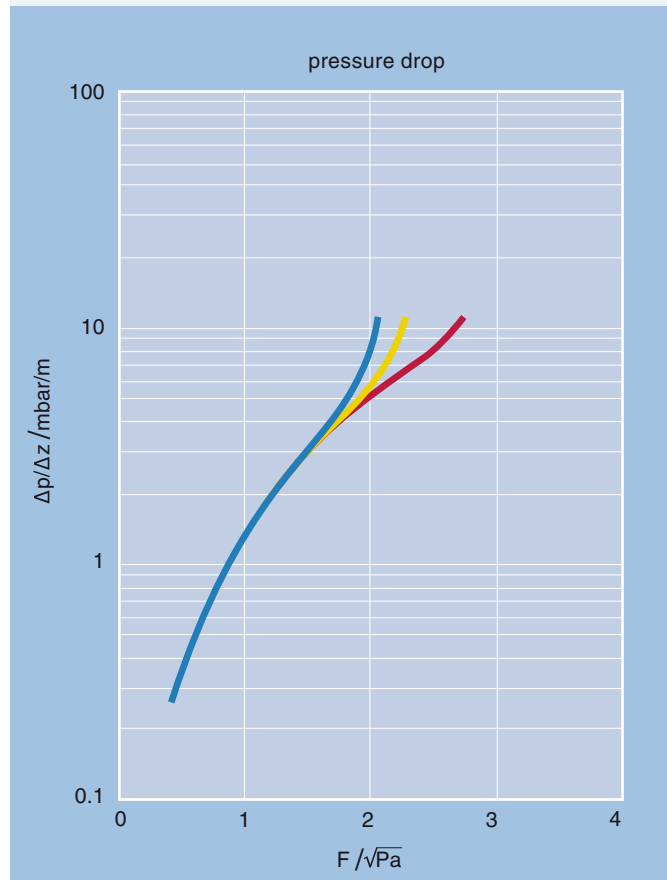

Katapak

# Sulzer columns – your solution

## Sulzer columns of sectional design

All internals can be installed through the column flange openings

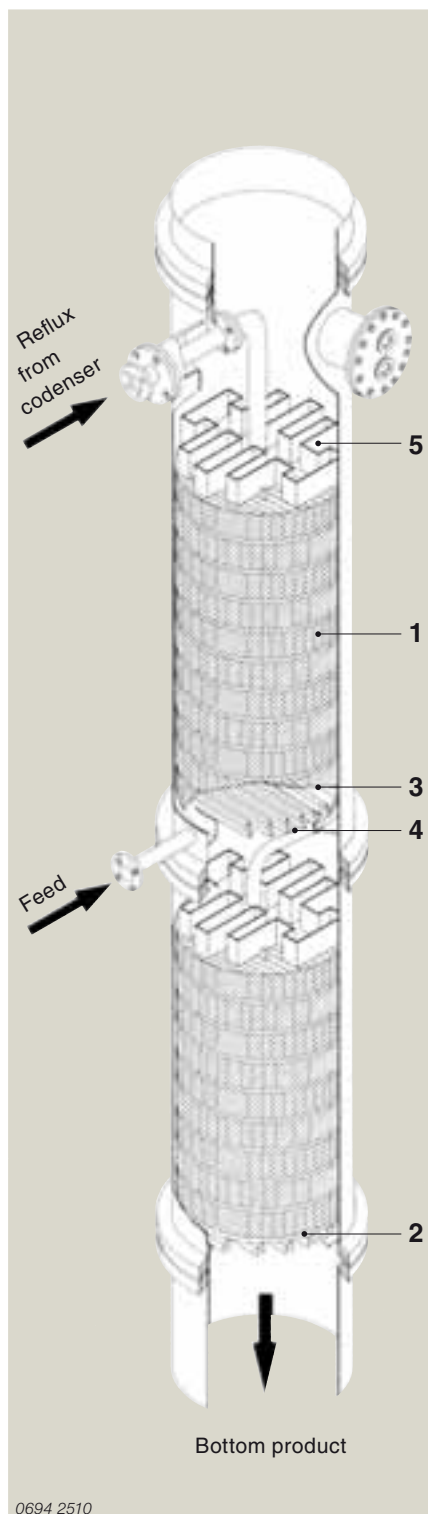

### Sulzer packing 1

in various types and different materials

### Support grid 2

for the packing

### Liquid collector 3

### Feed pipe 4

to distributor

### Liquid distributor 5

mounted on locating grid

### Locating grid 6

### Steam inlet pipe 7

### Column sump 8

### Circulation pipe to reboiler 9

### Skirt 10

### Anchorage 11

### Variations on the above design

Feed:

- vapor
- two phases with flash box

Side stream:

- liquid from collector
- vapor collector

0694 2510

## Welded column, monoblock type

All internals in segments for installation and removal through manhole, nominal diameter 500 up to 1000 mm

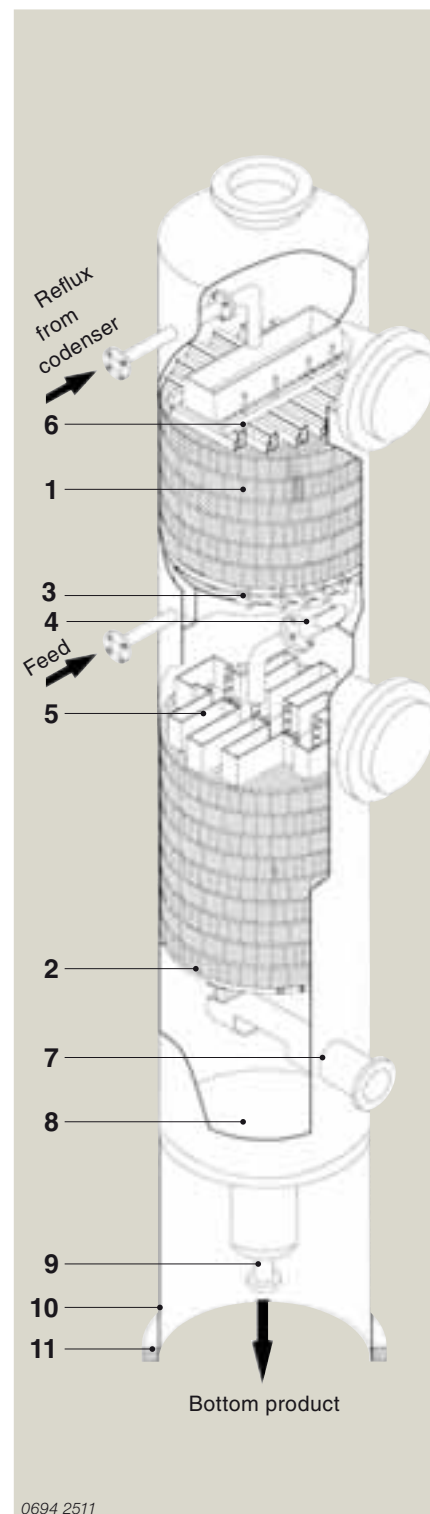

0694 2511

# Column internals

## Liquid distributors

### Discharge systems

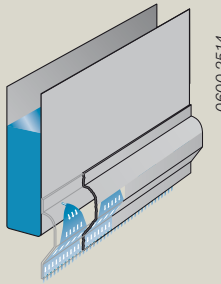

Type VEP



Type VKG

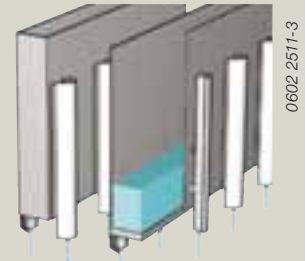

Type VKR 2

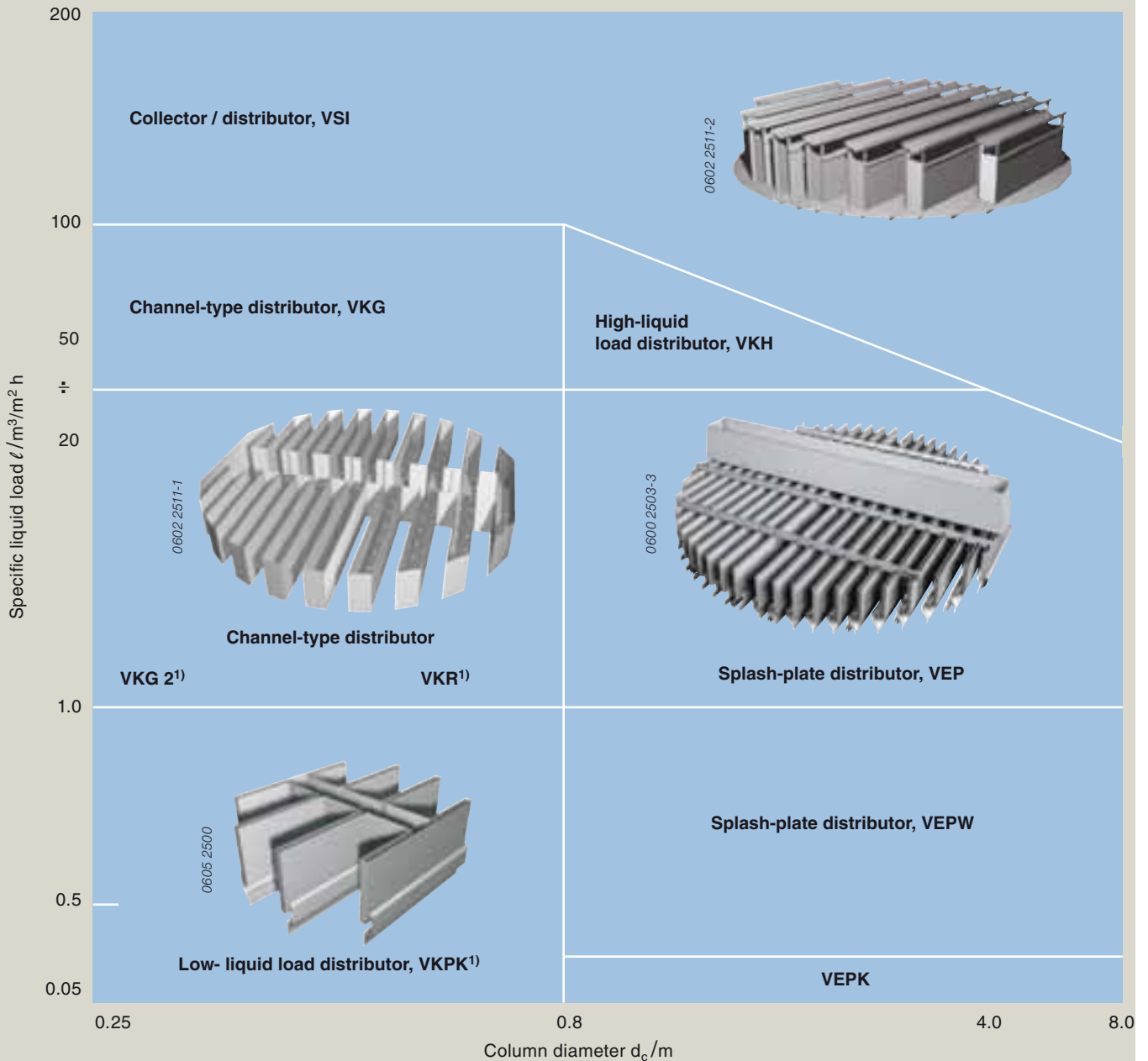

<sup>1)</sup> Can be supplied in a flanged version, also for diameters > 0.8 m

# Column internals

## Collector support grids

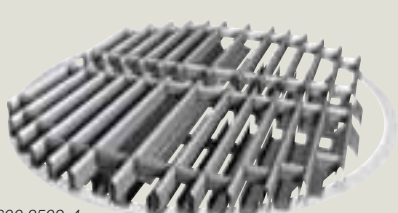
	Type	Column diameter	Features
 <p>0600 2509-4</p>	SLRT/SLMT	from 0.3 m	<p>The collector SLT is both a packing support and a vane collector. As a packing support, it can support the direct load of packings with surface areas up to 350 m<sup>2</sup>/m<sup>3</sup>. For finer packings, additional drip plates are used.</p> <p>This non-welded collector SLT is often used in applications where space between packed beds is limited. This collector requires a support ring inside the column</p>

## Collectors

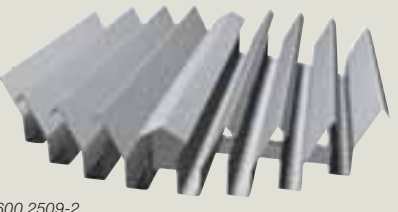
 <p>0600 2509-2</p>	SLR/SLM	from 0.3 m	<p>The vane collector SL is used as a separate unit to accumulate liquids from packed sections within a column. This collector requires a ring channel welded to the column wall.</p> <p>The collector SLF is designed to be installed between the column flanges in smaller flanged columns</p>
--	---------	------------	--

## Chimney trays

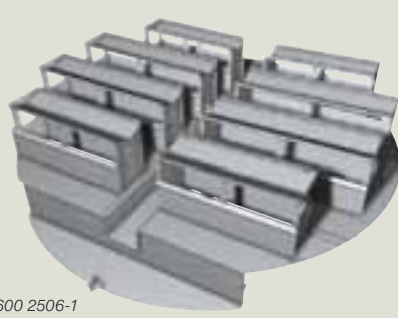
 <p>0600 2506-1</p>	SK	from 1 m	<p>The collector SK is an established and versatile tray design, available either in bolted or seal-welded construction. It is generally used in large diameter columns with high liquid loads</p>
--	----	----------	--

# Column internals

## Collector-distributor systems/Vapor distributor

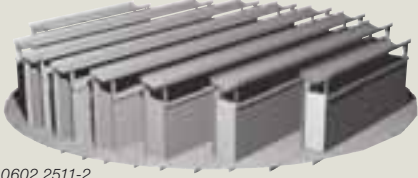
	Type	Column diameter	
 <p>0602 2511-2</p>	VSI	from 0.25 m	<p>The collector/distributor VS is used whenever collection and redistribution of liquid is required at very high liquid loads. It resembles a chimney tray; however the chimney arrangement is custom designed for your application's liquid distribution and pressure drop requirements.</p> <p>For moderate liquid loads applications, where liquid mixing is important, a separate accumulator tray must collect the liquid and feed it to a liquid distributor located below it.</p>

In addition, special collector-distribution systems are available, e.g. for use at increased pressures or - in conjunction with highly corrosion-resistant packings - in processes with aggressive media. Supplementary information is to be found in our brochure "Internals for Packed Columns".

## Support grids

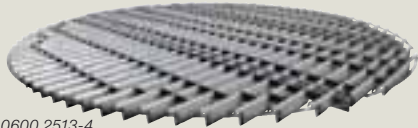
 <p>0600 2513-4</p>	TEB/TSB	0.5 to 10 m	<p>TEB and TSB are used with structured packings. Both require support rings to be welded to the column wall. TEB are supports for flanged columns. The segmental grids of the TSB pass through manholes and are clamped together for convenient installation. No welding is required.</p> <p>TEB and TSB support grids are ideal for applications requiring expensive high-alloys. Certain high performance packings require additional drip plates.</p>
---	---------	-------------	---

 <p>0600 2513-2</p>	TS/TE	from 0.1 m	<p>TE and TS are intended for structured packings with surface area over 350 m<sup>2</sup>/m<sup>3</sup> packing volume. They are designed with drip plates to prevent premature flooding of the packing.</p> <p>These support grids rest on support rings or gussets welded to the column shell. For columns over 3 m, additional supports and major beams may be required.</p>
---	-------	------------	--

# Revamping of existing columns

## Repacking the entire column cross-section

Along with other aspects, this modification serves to increase the throughput.

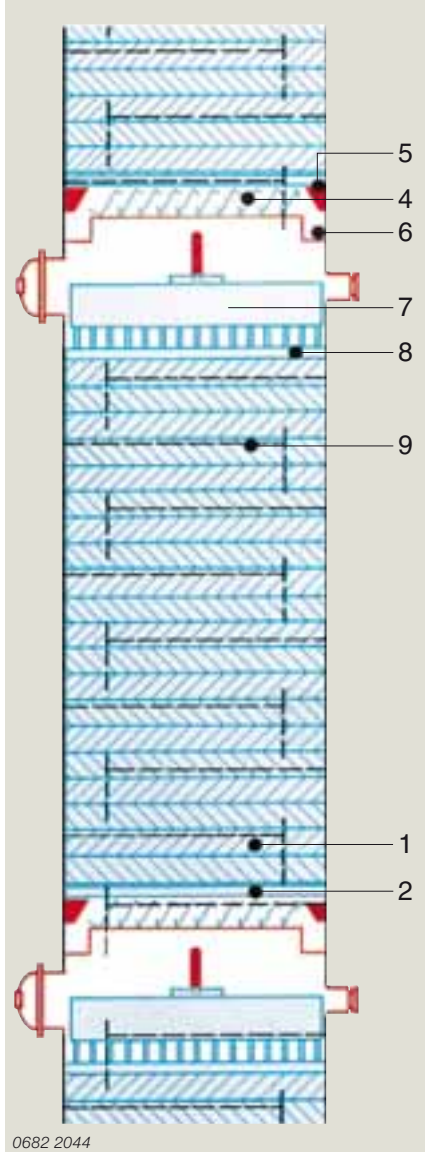

### Installation

The new column internals are installed through the manholes: support beam, support grid, packing, locating grid, distributor and collector.

## Repacking with column sleeve

To improve product purity without increasing capacity. Due to the good hydraulic performance of the Sulzer structured packings, the entire column cross-section is often not needed. The Sulzer packing is fitted inside a sleeve of smaller diameter.

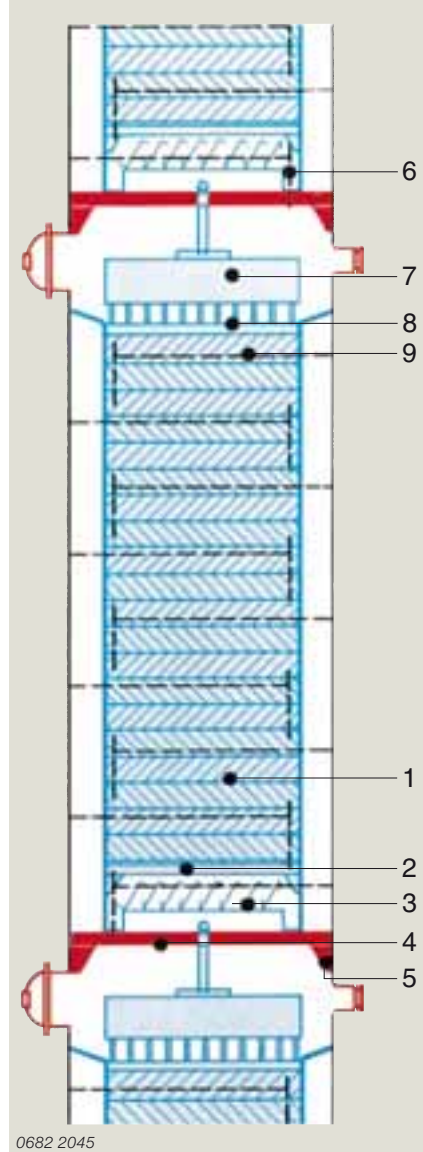

### Installation

The column head is taken off and the pre-assembled and pre-packed sleeves are lowered by crane onto the relative beams fitted in the column. The annular spaces are sealed off to prevent gas and liquid by-passing.

■ Existing column

■ Items supplied by Sulzer Chemtech

Installation either by the customer with Sulzer advising or complete installation service by Sulzer as the customer wishes.

- 1 Sulzer packing
- 2 Support grid
- 3 Support beam
- 4 Collector
- 5 Support lugs (welded-in)
- 6 Ring channel
- 7 Liquid distributor
- 8 Locating grid (hold-down grid)
- 9 Existing trays (incl. support rings)

### Repacking work

(Example for tray towers)

- Remove the trays
- Remove tray support rings (when required - depending upon the installation method of the packing)
- Weld in the support lugs, tie-bars and ring channels for the liquid collectors
- Provide manholes and sight glasses at the level of each liquid distributor
- Fit new feed and instrument connections, if necessary
- Clean the column

### Repacking time

Depending on the column size and personnel deployed, modifications to the existing column may take one to four weeks, and several days to two weeks for fitting the new parts.

# Installation



0695 2510-13

*Installation of packing*



0692 2512-18

*Revamping of a vacuum column with Mellapak*



0601 2505-2

*Inspecting packings after installation*



0683 2006-2

*The packing is fitted inside the column sleeves at the preassembly site*



0683 2006-1

*The column sleeve is lowered into the column with two cranes. Weight: 100 tons*



0602 2509-39

*Installation of the liquid distributor*



# Process design for thermal mass transfer and reaction

## Your objectives

In your existing plant, your aim is to:

- Increase capacity
- Improve product quality
- Save energy

You are investing in a new plant and are looking for support in

- Calculating the separation process
- Designing the column
- Optimizing the separation process, etc.

You are seeking solutions to problems with:

- Gas processing/exhaust air treating
- Removal of organic substances from the exhaust, possibly incorporating recuperation

Or you would like to carry out separation trials with your product in a pilot plant.

In all such cases, you can depend on our solutions and services to assist you in reaching your objectives.

## Our services

- Feasibility studies
- Column simulation  
Data balance and flowsheets  
Plant sizing  
Analysis of energy-saving potential  
Process calculations
- Column diagnostics  
Operating data analysis  
Bottleneck analysis  
Maldistribution analysis
- Troubleshooting
- Control concept  
Analysis, optimization, design
- Pilot tests with your product under realistic operating conditions
- Planning and execution of plant conversion (revamping)
- Support in start-up of columns and plant
- Training  
Schooling of plant personnel  
Courses on mass transfer (theory and practice)
- Compiling of software for solving special and difficult problems encountered in mass transfer

## Guarantee

40 years of experience in the field of thermal mass transfer using structured packings allow us to offer you not only optimum solutions but also provide you with guarantees regarding capacity, pressure drop and purity. Our guarantees are based on:

- Vapour-liquid equilibrium data based partially on our own measurements, or
- continuous or batch testing at pilot level in our technical laboratory on a semi-industrial scale, or
- pilot-scale trials at customer's works

and are often additionally confirmed by results from actual industrial-scale reference plants.



*Amine production plant.  
A number of columns are equipped  
with Sulzer structured packing*

0685 2073

# Separation technology laboratory

## Comprehensive customer service

### Distributor test facility

Uniform liquid distribution is decisive in securing good separation performance from a rectification/absorption column incorporating structured packings especially for columns of large diameter.

This requirement was recognized early on in the development of the Sulzer structured packings. Hence the geometrical configuration of the packings promotes liquid stream intersections and thus intermixing. Moreover, a whole series of liquid distributors has been developed, which are optimally matched for column diameter, packing type and operating conditions.

The distributor test facility has provided results which have contributed significantly to the construction of large distributors with diameters ranging from 3 m up to 15 m. As part of integrated quality control, all distributor types are fully tested before delivery to customers. Sulzer Chemtech is certified in accordance to ISO 9001:2000 and ISO 14001.



0600 2566-1  
*Distributors on the Sulzer Chemtech distributor test facility*

### Laboratories

Sulzer Chemtech has set up a process engineering laboratory in Winterthur, Switzerland. In addition to the further development and testing of structured packings, column internals and trays, this laboratory carries out customer trials and pilot tests. An analytical laboratory and trained personnel are available.



0682 2026  
*Multi-purpose pilot plant for the separation of mixtures by distillation, using Sulzer structured packings of various design.*

## Formula notation

		Metric Units	To convert to US Units multiply by	US Units
G	Gas flow	kg/h	2.205	lb/h
g	Gas load per square meter (related to empty column)	kg/m <sup>2</sup> h	0.2048	lb/ft <sup>2</sup> h
L	Liquid flow	kg/h m <sup>3</sup> /h	2.205 4.403	lb/h gpm
ℓ	Specific liquid load (related to empty column)	m <sup>3</sup> /m <sup>2</sup> h	0.4090	gpm/ft <sup>2</sup>
NTS	Number of theoretical stages	(-)		
NTSM	Number of theoretical stages per meter packed height	m <sup>-1</sup>	0.3048	ft <sup>-1</sup>
NTUM	Number of transfer units per meter packed height	m <sup>-1</sup>	0.3048	ft <sup>-1</sup>
HETP	Height equivalent to a theoretical plate	m	39.37	in
c <sub>G</sub>	Load factor = $w_G \sqrt{\rho_G / (\rho_L - \rho_G)}$	m/s	3.281	ft/s
F	F factor = $w_G \cdot \sqrt{\rho_G}$	m/s $\sqrt{\text{kg/m}^3} = \sqrt{\text{Pa}}$	0.8197	ft/s $\sqrt{\text{lbm/ft}^3}$
w <sub>G</sub>	Superficial gas velocity (related to empty column)	m/s	3.281	ft/s
ρ <sub>G</sub>	Gas density	kg/m <sup>3</sup>	0.06243	lb/ft <sup>3</sup>
ρ <sub>L</sub>	Liquid density	kg/m <sup>3</sup>	0.06243	lb/ft <sup>3</sup>
M	Molar mass	kg/kmol	1.000	lb/lb-mol
p	Operating pressure	mbar bar	0.7501 14.50	mm Hg psia
Δp/Δz	Pressure drop per unit height	mbar/m	0.1224	in H <sub>2</sub> O/ft
T	Operating temperature	K	1.800	R
A <sub>c</sub>	Column cross-section	m <sup>2</sup>	10.76	ft <sup>2</sup>
d <sub>c</sub>	Column diameter	m	3.281	ft
ψ	Flow parameter = $L/G \cdot \sqrt{\rho_G / \rho_L}$	(-)		

**Headquarters**

Sulzer Chemtech Ltd  
P.O. Box 65  
8404 Winterthur, Switzerland  
Phone +41 52 262 50 28  
Fax +41 52 262 01 82  
chemtech@sulzer.com  
www.sulzerchemtech.com

**North and South America**

Sulzer Chemtech USA, Inc.  
8505 E. North Belt Drive  
Humble, TX 77396, USA  
Phone +1 281 441 5800  
Fax +1 281 291 0207

**Asia, Pacific**

Sulzer Chemtech Pte. Ltd.  
10 Benoi Sector  
Singapore 629845  
Phone +65 6515 5500  
Fax +65 6862 7563

Sulzer Chemtech Ltd, a member of the Sulzer Corporation, with headquarters in Winterthur, Switzerland, is active in the field of process engineering and employs some 2500 persons worldwide.

Sulzer Chemtech is represented in all important industrial countries and sets standards in the field of mass transfer and static mixing with its advanced and economical solutions.

The activity program comprises:

- Process components such as trays, structured and random packings, internals for separation columns and reaction technology
- Engineering services for separation and reaction technology such as optimizing energy consumption, plant optimization studies, pre-engineering for governmental approval, basic engineering
- Separation and purification of organic chemicals by means of crystallization and membranes
- Mixing and reaction technology with static mixers
- Mixing and Cartridges Technology
- Tower field services

Distributed by:

